

Piezoelectric Noise: MLCC Ringing - Singing

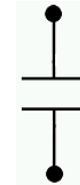

Possible solutions for reducing or eliminating MLCC ringing – singing issues

- *Modified PCB materials or layout (page 3)*
- *Lower K Dielectric MLCCs (page 4)*
- *SMT Film Capacitors (pages 5 ~ 16)*

Piezoelectric effect in MLCCs (Multilayer Ceramic Chip Capacitors)

MLCCs (Multi Layer Ceramic Capacitor) have **several advantages**

- low Equivalent Series Resistance (ESR)
- low Equivalent Series Inductance (ESL)
- small size
- non-polarized

A **disadvantage** of the MLCC can be the **piezoelectric nature** of the ceramic material. MLCCs are made from ceramic dielectrics (*which have ferroelectric properties*), which can exhibit problematic or disruptive noise (*ringing or singing*) due to oscillations with PCB.

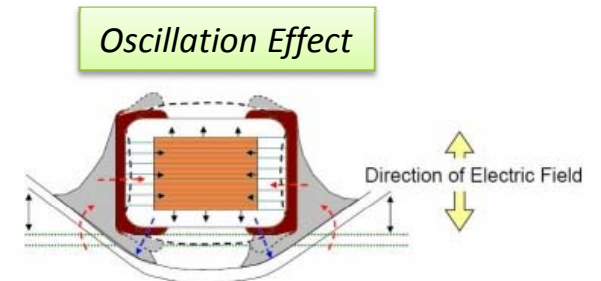

Contributors to Ringing – Singing Noise in circuits using MLCCs:

- Operating frequency of signal (*or harmonics*) within the audible range (20Hz ~ 20KHz)
- Operating voltage ... higher signal voltage produces higher SPL (sound pressure level)
- Ceramic dielectric constant (K) ... Higher K ceramics exhibit higher ferroelectric properties
- Ceramic layer thickness ... Higher voltage rated MLCVC have thicker ceramic layers and typical exhibit lower SPL

Voltage vs. SPL

Images from EE Times - April 2012
"Reducing MLCCs' piezoelectric effects and audible noise"
by Nicolas Guibourg, Texas Instruments Germany

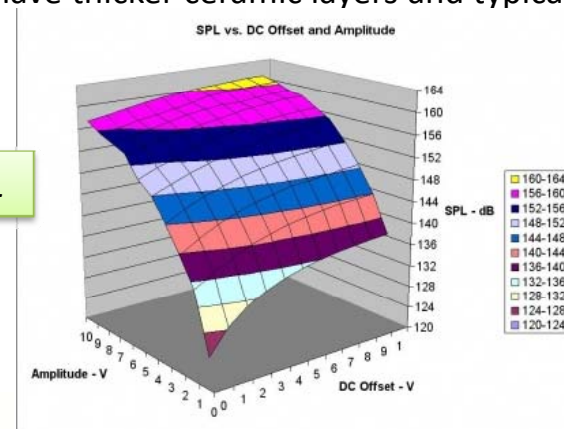

Contributors to Ringing – Singing Noise in circuits using MLCCs:

PCB = Printed Circuit Board

- PCB material and thickness ... The thicker the PCB, more resistant it is to deformation and the lower SPL it produces
- PCB layout
 - MLCC capacitor placed at the edge of the PCB will be preferred (lower SPL) to placement away from edge of PCB.
 - Placed next to each other, MLCC capacitors generate higher overall SPL (+14 dB between a single capacitor and three placed in parallel).
 - On the contrary, when placed symmetrically on each side (opposite sides) of the PCB board *as shown in below figure*, MLCC capacitors tend to cancel out each other's vibrations.

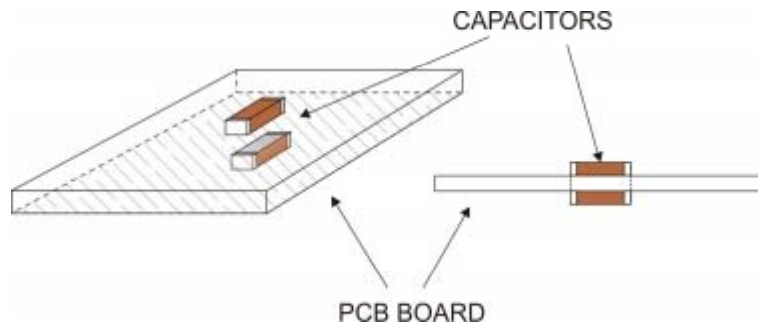

Oscillation effects reduced when mounting MLCCs symmetrically opposite one another

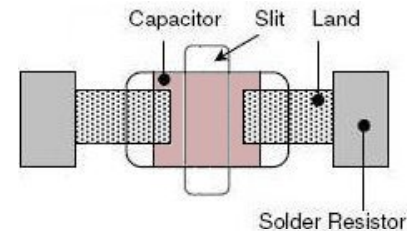

Slit in PCB added under MLCC can help to reduce coupling to PCB and reduce SPL

Image from EE Times - April 2012
"Reducing MLCCs' piezoelectric effects and audible noise"
by Nicolas Guibourg, Texas Instruments Germany

Potential Remedies

Goal: Reduce SPL to acceptable levels

- Use **MLCC with lower dielectric constant** (K)
- Replace high K dielectrics Y5V / X5R / X7R **with NPO dielectric** (low K)
- Below table shows maximum capacitance values for 50V, 100V and 250V rating in **NPO dielectric** MLCCs (3-digit capacitance code & corresponding capacitance value) for 0402 case size to 2225 case size



	0402	0603	0805	1206	1210	1808	1812	2220	2225
50V	471 (470pF)	332 (3300pF)	153 (0.015uF)	223 (0.022uF)	223 (0.022uF)	473 (0.047uF)	104 (0.10uF)	224 (0.22uF)	224 (0.22uF)
100V		102 (1000pF)	103 (0.01uF)	223 (0.022uF)	223 (0.022uF)	333 (0.033uF)	823 (0.082uF)	104 (0.10uF)	104 (0.10uF)
250V		471 (470pF)	392 (3900pF)	103 (0.01uF)	103 (0.01uF)	223 (0.022uF)	473 (0.047uF)	823 (0.082uF)	823 (0.082uF)

PART NUMBER SYSTEM

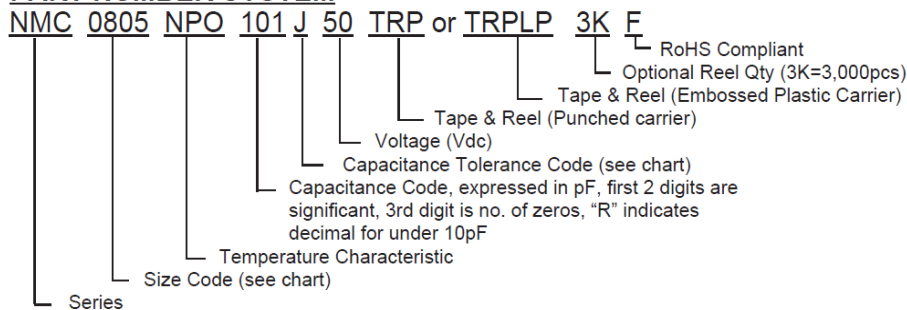

*Added benefit of using **NPO** is far greater stability over voltage, temperature and time as compared to X7R / X5R / Y5V dielectric*

NSPH Series - SMT Film Chip Capacitors

- *Page 6 - Introduction*
- *Page 7 – CV Sizes*
- *Page 8 – Construction & Advantages*
- *Page 9 - Voltage Coefficient Comparison*
- *Page 10 - Temperature Coefficient Comparison*
- *Page 11 - Leakage Current Comparison*
- *Page 12 – Low Noise (distortion) Comparison*
- *Page 13 – Dielectric Absorption Comparison*
- *Page 14 – CV Sizes Compared to MLCCs*
- *Pages 15 & 16 – Applications & Replacing LDD types*

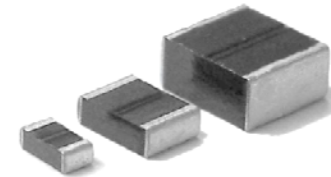
NSPH - High Capacitance SMT Film Chip Capacitors**NSPH series, High Capacitance SMT Film Chip Capacitors**

NIC Components is pleased to announce the addition of NSPH series of High Capacitance Multilayer Polymer Film SMT Chip Capacitors. Supplied in four EIA surface mount cases sizes; 1206, 1210, 1812 & 2220 in capacitance values from 0.1uF to 22uF with voltage ratings from 16V ~ 63VDC (11V ~ 45Vrms). NSPH series is rated for operating temperatures of -55°C to +125°C with typical capacitance change within $\pm 5\%$ of 25°C capacitance value.

NSPH series is RoHS compliant and is halogen free. Supplied tape and reel packaged, for high speed automated placement and compatible with high temperature Pb-Free alloy soldering (+260degC soldering heat rated). NSPH unit pricing range from \$0.39 ~ \$1.09 with production lead times of 8 to 10 weeks. Please contact NIC today for Free component samples and to review your requirements.

Features:

- High Capacitance in Small Case Sizes
- Stable Cap Value over Voltage, Temperature & Time
- Low Noise for Digital Audio Streamer applications
- **Reduce or eliminate MLCC Piezoelectric Effects**
 - **Capacitor singing or ringing effects**
- Low Dielectric Absorption for use in A to D applications (*10X ~ 20X improvement over X7R MLCCs*)
- Self healing construction (open mode failure)
 - *Free of component cracking failures (MLCC weakness)*
- High IR; low leakage current performance (compared to high cap X5R MLCCs)
- Replace large leaded film capacitors with small low profile (low ESL) SMT chip
- RoHS compliant and Halogen Free

SMT Film Capacitors; Series & Case Sizes

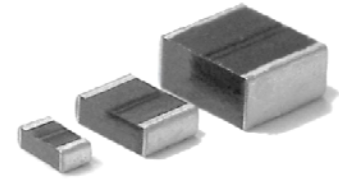

Voltage Rating (VDC)	NSWC 1913~2420		NSWC 2420																																				
250V	NSWC 1913~2420		NSWC 2420																																				
100V	NSWC 1206~1210		NSWC 1210	NSWC 1913	NSWC 1913	NSWC 2416	NSWC 2416	NSWC 2820																															
	NSHC 1913~2820		NSHC 2820	NSHC 2825																																			
			NSMX 2218	NSMX 3021	NSMX 3022	NSMX 3024	NSMX 3026	NSMX 4028	NSWC 2820	NSWC 3022	NSWC 3925	NSWC 3925																											
63V								NSPH 1206	NSPH 1210	NSPH 1210	NSPH 1812	NSPH 1812	NSPH 1812	NSPH 2220	NSPH 2220																								
50V	NSHC 0805~1913		NSHC 1913	NSHC 2416	NSPH 1206	NSPH 1206	NSPH 1206	NSPH 1210	NSPH 1210	NSPH 1812	NSPH 1812	NSPH 1812	NSPH 2220	NSPH 2220	NSPH 2220																								
35V								NSPH 1206	NSPH 1206	NSPH 1210	NSPH 1210	NSPH 1812	NSPH 1812	NSPH 1812	NSPH 2220	NSPH 2220																							
25V								NSPH 1206	NSPH 1206	NSPH 1210	NSPH 1210	NSPH 1812	NSPH 1812	NSPH 1812	NSPH 2220	NSPH 2220																							
16V								NSPU 0805	NSPU 1206	NSPU 1206	NSPU 1206	NSPU 1206	NSPU 1206	NSPH 1206	NSPH 1206	NSPH 1210	NSPH 1210	NSPH 1812	NSPH 1812	NSPH 1812	NSPH 2220	NSPH 2220																	
	NSHC 0603~1210		NSHC 1210								NSPU 1210																												
6.3V																																							
	< 0.01uF	0.01uF	0.022uF	0.047uF	0.1uF	0.15uF	0.22uF	0.33uF	0.47uF	0.68uF	1.0uF	1.5uF	2.2uF	3.3uF	4.7uF	6.8uF	10uF	15uF	22uF																				
Capacitance Value																																							

NSPH series
High Capacitance SMT Film Chip Capacitors

- High Capacitance
- Reduced Case Sizes
- High Voltage @ >1uF

NSPH - High Capacitance SMT Film Chip Capacitors**CONSTRUCTION**

Part	Materials	
1	Capacitor Element	Acrylic base polymer film
2	Internal Electrode	Vapor deposited aluminum
3	First Termination Layer	Copper alloy
4	Second Termination Layer	Conductive paste
5	Third Termination Layer	100% Sn (tin) plating

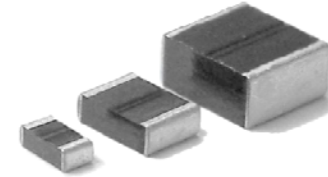
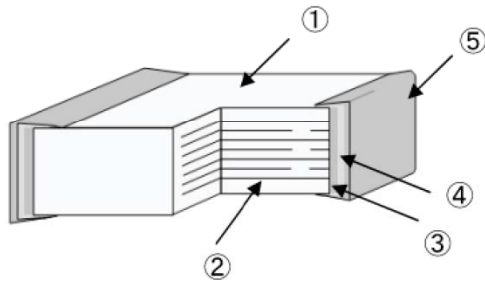

NSPH is ideal for use in green power, network infrastructure, instrumentation, high-end audio, digital audio streaming equipment and audio DAC applications.

NSPH series have many advantages over high capacitance MLCCs (X5R& X7R) capacitors:

- ✓ Higher voltage ratings (15uF & 22uF)
- ✓ **Stability over voltage, temperature and time**
- ✓ The low loss film construction is **free from piezoelectric noise** (MLCC distortion)
- ✓ Free from MLCC cracking failures
- ✓ Superior **low leakage current characteristics** for green power applications (high efficiency)
- ✓ **Low dielectric absorption** characteristics, *10X ~ 20X improvement over X7R MLCCs*
- ✓ **Open-mode failure** advantage of NSPH series, compared to short-circuit failure mode of MLCC capacitors.

NSPH - High Capacitance SMT Film Chip Capacitors

NSPH stability advantage over high capacitance MLCCs capacitors

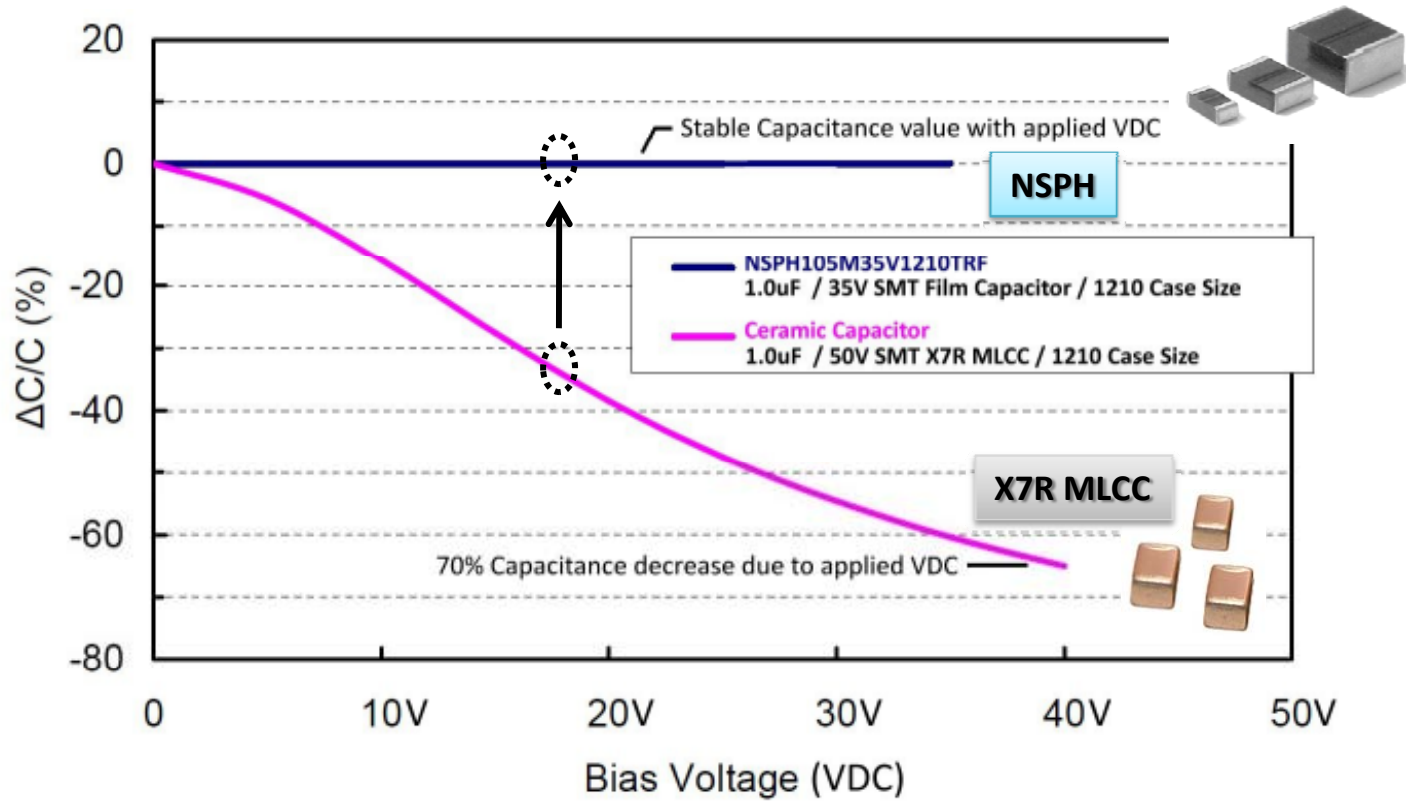

NSPH - High Capacitance SMT Film Chip Capacitors

NSPH advantage over high capacitance MLCCs capacitors

Typical Capacitance vs. Temperature
(NSPH vs. MLCC)

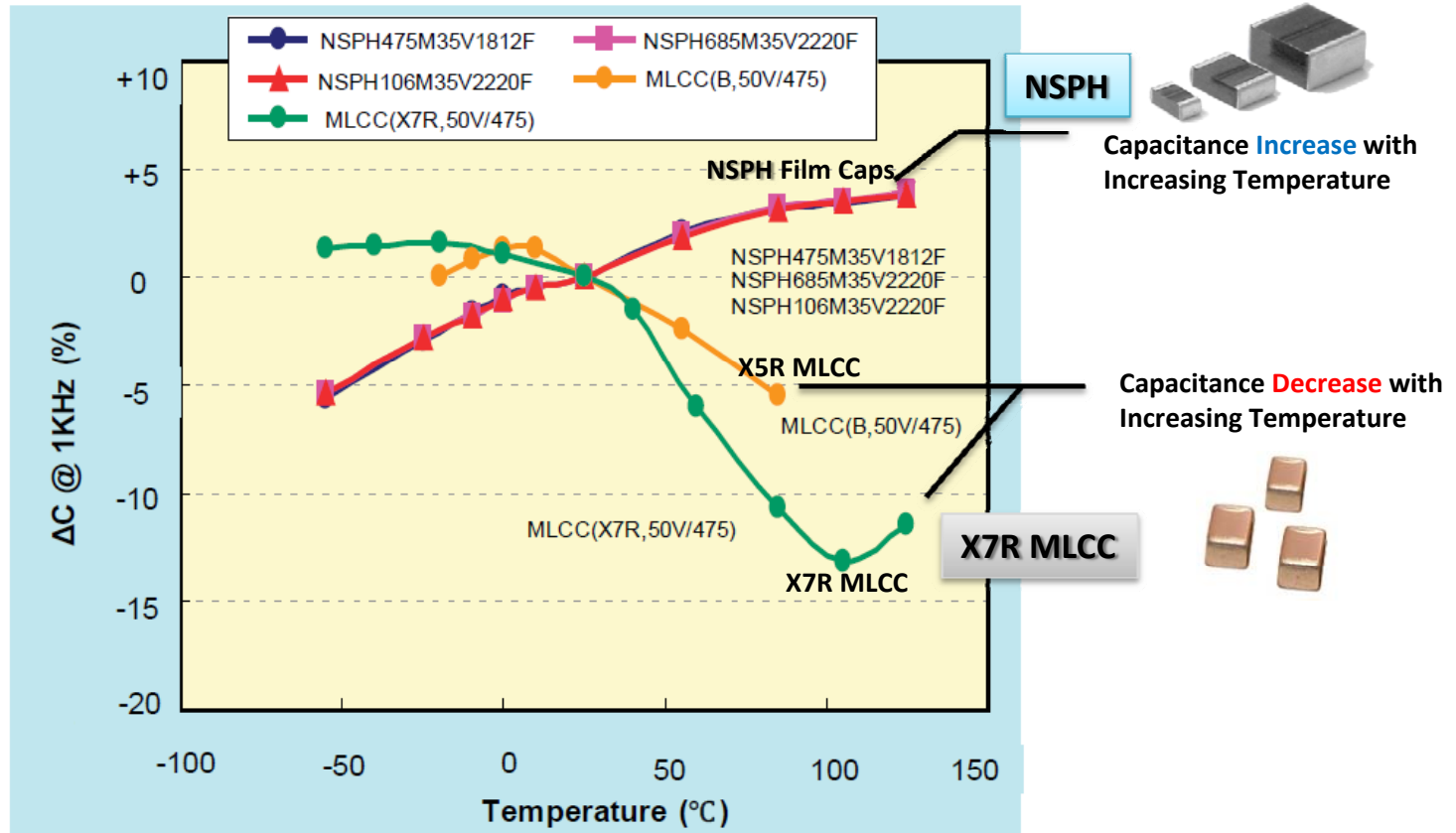

Capacitance **Increase** with Increasing Temperature



Capacitance **Decrease** with Increasing Temperature

NSPH - High Capacitance SMT Film Chip Capacitors

NSPH lower leakage current advantage compared to high capacitance MLCCs capacitors

Type	IR Insulation Resistance	22uF Capacitor Leakage Current @ 5VDC Operation	Using 4 Capacitors Energy Loss due to Capacitor LC
NSPH NSPH Film Cap	> 300MΩ • μF	0.37 uA	up to 1.5 uA
X7R MLCC MLCC X5R & X7R	" > 50Ω • F " > 50MΩ • μF	2.2uA	up to 8.8uA

← **6 X Improvement**

6 Insulation Resistance More than 50Ω · F

X5R & X7R MLCC

Insulation Resistance (20°C) > 300MΩ · μF

NSPH Film Caps

NSPH - High Capacitance SMT Film Chip Capacitors

NSPH lower distortion advantages over high capacitance MLCCs capacitors

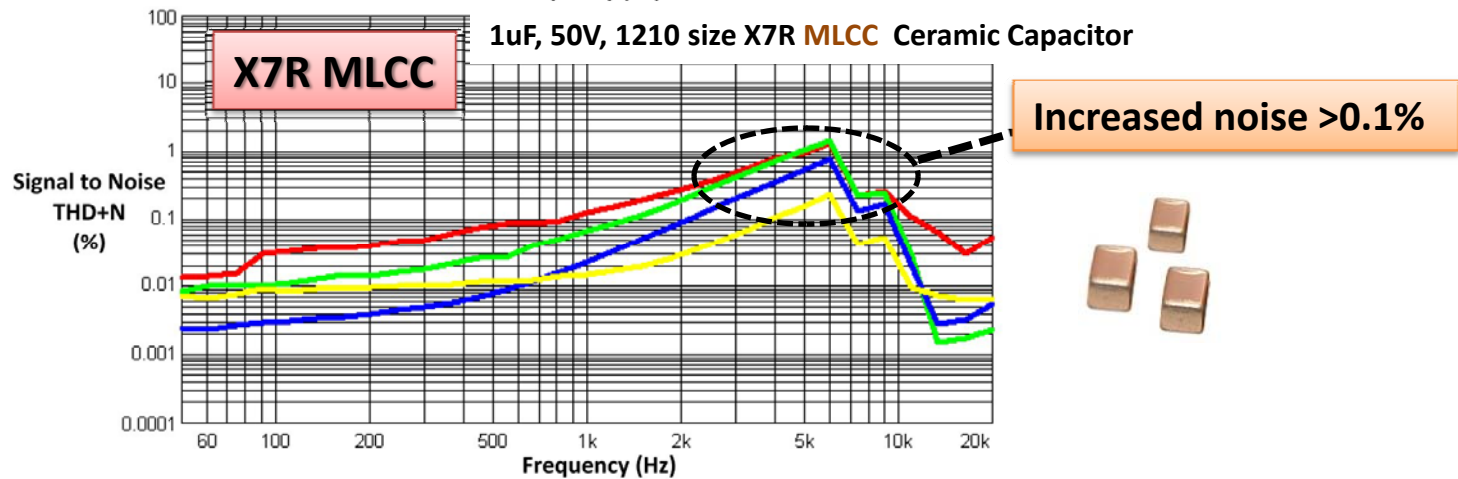
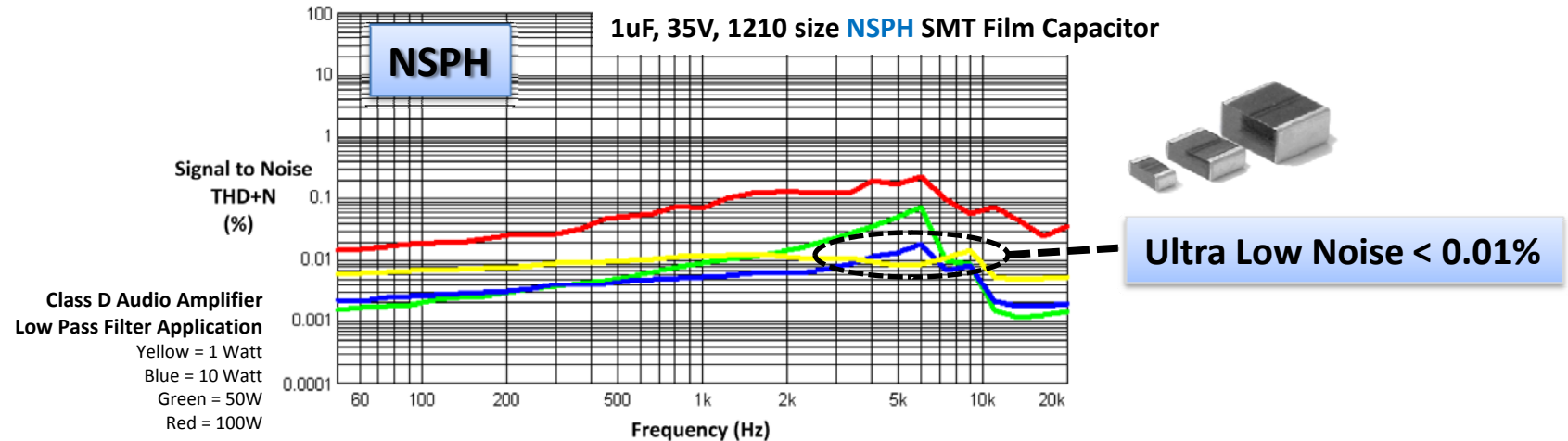

THD+N is a sum of harmonic distortion components and noise

NSPH - High Capacitance SMT Film Chip Capacitors

NSPH lower dielectric absorption advantages over high capacitance MLCCs capacitors

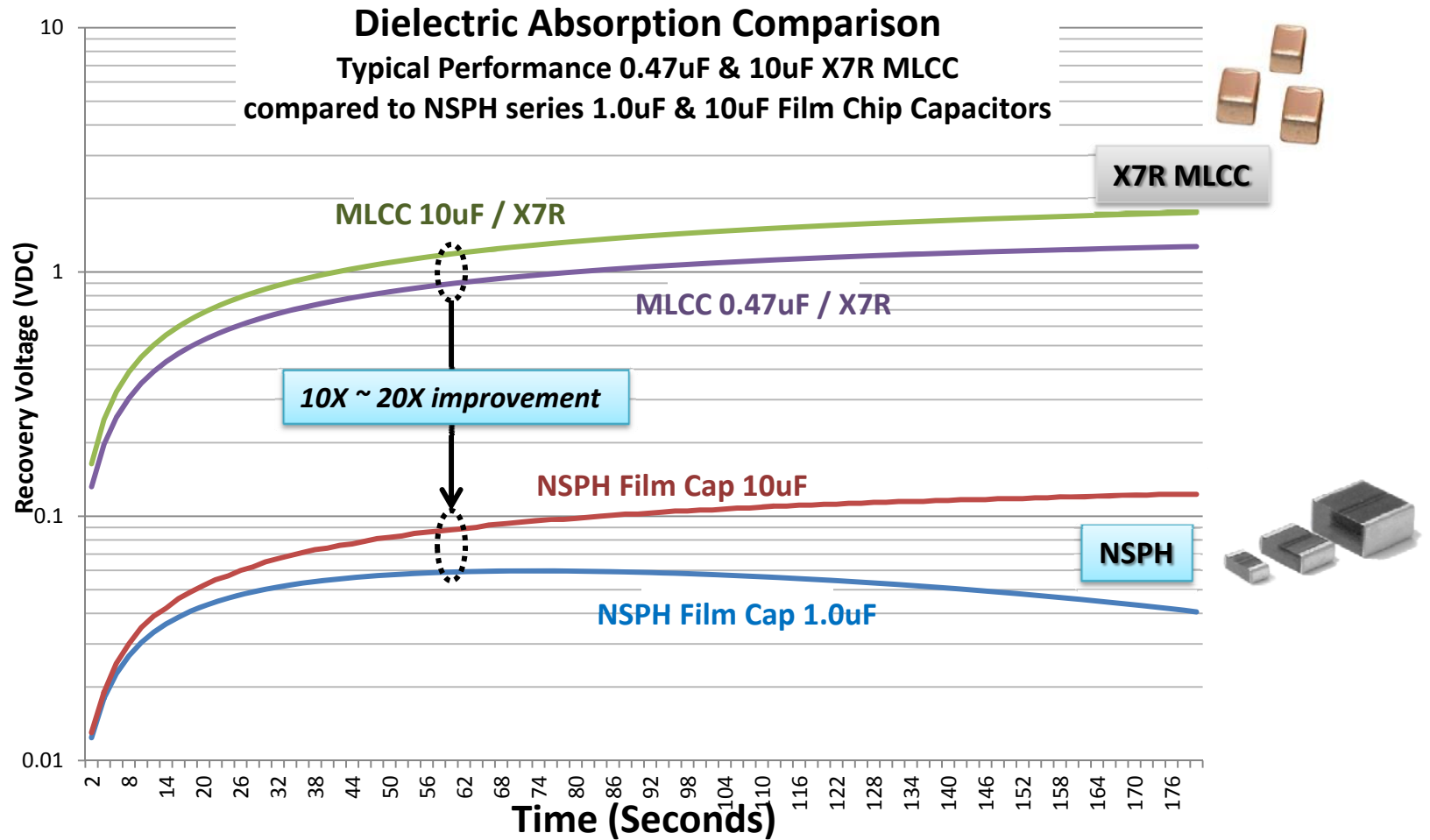

SMT Ceramic MLCC Capacitors; TCs & Case Sizes



NSPH series
High Capacitance SMT Film Chip Capacitors

Voltage Rating (VDC)											
100V	X7R 1210, 1812, 1825, 2220, 2225	X7R 1210, 1812, 1825, 2220, 2225	X7R 1210, 1812, 2220, 2225	X7R 2220 & 2225	X7R 2220 & 2225						
50V	X7R 0805, 1206, 1210, 1812, 1825, 2220	X7R 1210, 1812, 1825, 2220	X7R 1210, 1812, 1825, 2220	X7R 1812, 1825, 2220	X7R 1812, 1825, 2220	X7R 2220	X7R 2220				
35V				NSPH 1812	X7R 1210			NSPH 2220	← Advantage NSPH		
			X5R 1210	↑ Advantage NSPH			↓ Advantage NSPH	X5R 1210			
25V	X7R 0805, 1206, 1210, 1812, 2225	X7R 2225	X7R 1206, 1210, 2225	X7R 1206 & 1210	X7R 1206	NSPH 2220	X7R 1210 & 1812	↓ Advantage NSPH			
	X5R 0603 & 0805		X5R 0805 & 1206	X5R 1206	X5R 1206 & 1210	NSPH 1812	X5R 1206 & 1210	NSPH 2220	↓ Advantage NSPH		
16V	X7R 0603, 0805, 1206, 1210, 1812			X7R 1206	X7R 0805, 1206, 1210	↓ Advantage NSPH	X7R 1206 & 1210	NSPH 2220	NSPH 2220		
	X5R 0402, 0603, 0805	X5R 1206	X5R 0603, 0805, 1206	X5R 1206	X5R 0805, 1206, 1210	NSPH 1812	X5R 0805, 1206, 1210		X5R 1206 & 1210		
10V	X7R 0603, 0805, 1206, 1210, 1812			X7R 1206	X7R 0805, 1206, 1210		X7R 1206 & 1210				
	X5R 0402, 0603, 0805		X5R 0402, 0603, 0805, 1206	X5R 0805 & 1206	X5R 0603, 0805, 1206, 1210		X5R 0805, 1206, 1210		X5R 1206 & 1210		
6.3V				X7R 0805	X7R 0805		X7R 1206				
	X5R 0402, 0603, 0805		X5R 0402	X5R 0603, 0805, 1206	X5R 0402, 0603, 0805, 1206, 1210	X5R 1206	X5R 0805, 1206, 1210		X5R 0603, 0805, 1206	X5R 1206 & 1210	X5R 1210
4V							X5R 0603		X5R 1206		
	1.0uF	1.5uF	2.2uF	3.3uF	4.7uF	6.8uF	10uF	15uF	22uF	47uF	100uF
Capacitance Value											



Please review to assure NSPH meets **circuit voltage** and **current requirements** of circuit

NSPH - High Capacitance SMT Film Chip Capacitors

Small SMT Film Capacitors
NSPH series

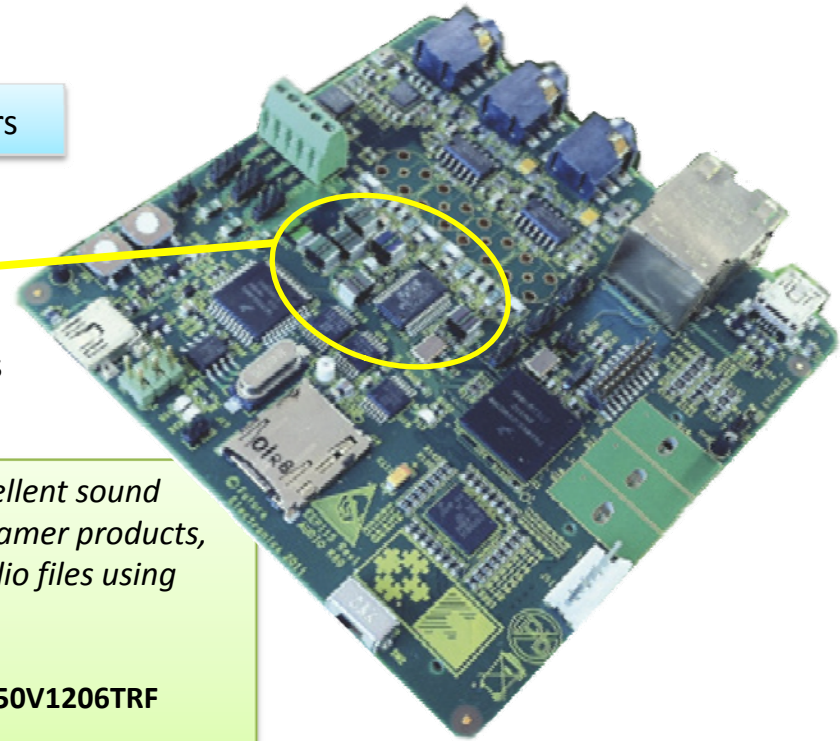

NSPH series, SMT Film capacitors contribute to “excellent sound reproduction and very low distortion” ... in Audio Streamer products, decoding FLAC, WAV, MP3 and Ogg Vorbis digital audio files using ARM Cortex-M4 embedded processor

100nF (0.1uF) /1206 / **NSPH/20% /50V = PN: NSPH104M50V1206TRF**

10uF/1812/NSPH**/20%/16V = PN: NSPH106M16V1812TRF**

Applications:

- *High-End Audio*
- *Digital audio streaming and audio DAC applications*
- *Battery Powered: Handheld & Portable Devices*
- *Green Power*
- *Test & Instrumentation*
- *Network Infrastructure*

NSPH - High Capacitance SMT Film Chip Capacitors

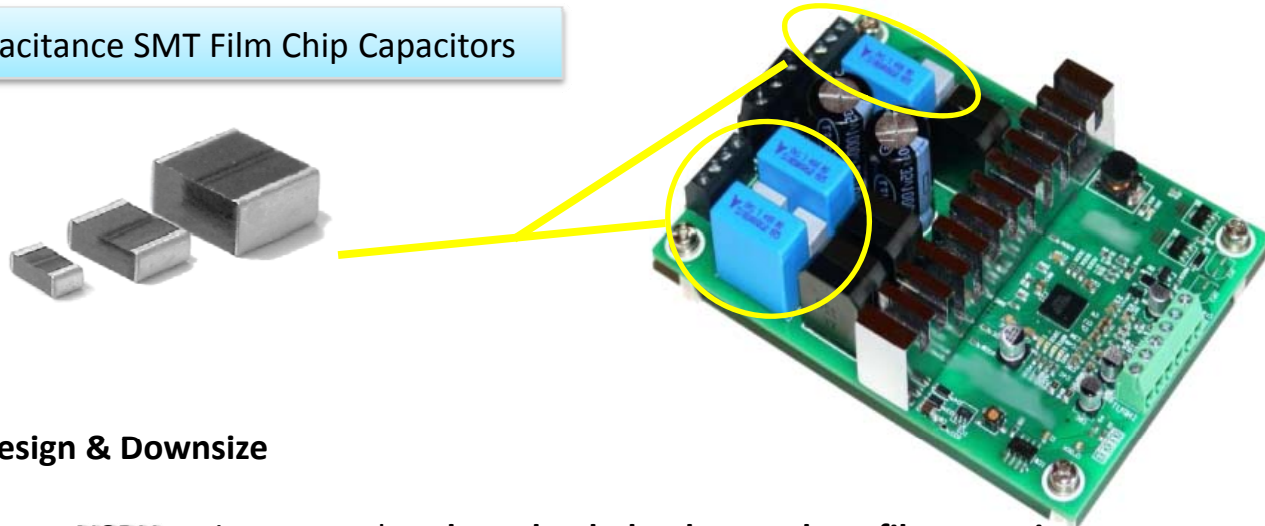

Circuit Redesign & Downsize

Small SMT type **NSPH** series can replace **large leaded polypropylene film capacitors**

* Please review to assure NSPH meets circuit voltage and current requirements of circuit

EIA surface mount cases sizes

- 1206 (3.2mm x 1.6mm x 1.6mm)
- 1210 (3.2mm x 2.5mm x 2.2mm)
- 1812 (4.5mm x 3.2mm x 2.8mm)
- 2220 (5.7mm x 5.0mm x 2.8mm)

Downsize from large radial leaded film capacitor in **18mm x 18mm x 9mm size** to small SMT film capacitor in **5.7mm x 5.0mm x 2.8mm size**

Capacitance = 10 μ F
 Voltage Rating AC = 40V (63VDC)
 Dielectric Material = Polyester
 Package / Case = Radial Box Type
 Size / Dimension L x W = **18.0mm x 9.0mm**
 Height (Max) H = **17.5mm**
 Lead Spacing LS = **15.00mm**



Additional Information Needed? Need Samples?

Technical Support: tpmg@niccomp.com
Sales Support: sales@niccomp.com

-  European Engineering Support
-  North America Engineering Support
-  SE Asia Engineering Support

NIC Components offers **unique performance passive components** that provide advantages to design engineers to create high performance end products in smaller and lower total cost formats

- Surface Mount SMT formats (*high speed auto placement*)
- Pb-Free Reflow Compatible (*high temperature reflow*)
- Performance advantages over competing technologies

NIC Components Corp.