



Hammond Power
Solutions Inc.

Introduction to Power Quality

**Hammond Power Solutions Inc.
595 Southgate Dr., Guelph, ON
Canada, N1G 3W6
(888)798-8882**

**Hammond Power Solutions Inc.
1100 Lake Street
Baraboo, WI 53913
(800)537-0500**

www.hammondpowersolutions.com

Table of Contents

Power Quality

INTRODUCTION	3
ELECTRICAL PROBLEMS RELATED TO POWER QUALITY	3
Power Factor Calculations	4
Power Factor Measurements.....	5
EQUIPMENT	5
ELECTRICAL PROBLEMS VS. COMPUTERS	5
ELECTRICAL PROBLEMS ON NON-LINEAR ELECTRICAL SYSTEMS.....	5
ELECTRICAL DISTRIBUTION SYSTEMS	6
ELECTRICAL CONDUCTORS	7
THREE-PHASE TRANSFORMERS.....	8
<i>Neutral Problems</i>	8
<i>Transformer Heating</i>	8
MOTORS	8
CAPACITORS	8
VARIABLE SPEED DRIVES	8
PROTECTION OF ELECTRICAL SYSTEMS	9
CIRCUIT BREAKERS AND FUSES	10
PEAK CUT-OFF CIRCUITS.....	10
SINGLE-PHASE LINE CONDITIONING TRANSFORMERS	10
VOLTAGE REGULATING TRANSFORMERS	10
ISOLATED DELTA-WYE TRANSFORMERS.....	10
T-CONNECTION TRANSFORMERS (THREE PHASES, TWO COILS).....	11
K-TYPE DELTA-WYE FOR NON-LINEAR LOADS	11
THE ZERO SEQUENCE FILTER	11
PHASE ANGLES	12
<i>The Harmonic Mitigating Transformer (0°-30° primary-secondary phase shift)</i>	12
<i>The Harmonic Mitigating Transformer Double Output</i>	13
STANDBY POWER SUPPLY SYSTEMS	13
UNINTERRUPTIBLE POWER SUPPLIES	13
THE "ON LINE" DOUBLE CONVERSION UPS	13
THE "ON LINE" SIMPLE CONVERSION UPS	14
THE "INTERACTIVE ON LINE" SIMPLE CONVERSION UPS.....	14
UNINTERRUPTIBLE POWER PLANTS.....	14
THE INSTALLATION OF DEDICATED OUTLETS FOR COMPUTERIZED EQUIPMENT	14
THE IDEAL APPROACH	15
Type of Receptacles 15A –120V	15
DEDICATED OUTLETS	15
INSTALLATION OF OUTLETS	15
PANEL PLACEMENT.....	16
GLOSSARY OF TERMS.....	16

Power Quality

Introduction

More and more, electricity is being considered a product. Ideally, the AC voltage wave is a sine wave alternating from a positive peak to a negative peak 60 times per second (60 Hz) without any deformations, spikes or surges. In reality, different factors influence the quality of the wave. Certain disturbances come directly from the power source, such as lightning. Other disturbances come from loads; in particular, from electronic equipment which are non-linear loads that produce harmonics, mostly because of their switching power supply.

Electrical Problems Related to Power Quality

Voltage spikes arise when equipment that operates on high current is turned off. Air conditioners, photocopiers, coffee makers, electric tools, etc. are all examples of this.

Noise can be generated from any temporary high frequency (harmonic from 50 kHz to 100 MHz), from a radio frequency (RFI) or from the production of electromagnetic interference (EMI) emitted from transformers or motors (often an elevator motor or a motor from a photocopier). As well, magnetic fields, induced by a mono-phased cable or by an unbalanced three-phased system, can deform images on a cathodic screen (computer monitor) or destroy data on a hard disk.

There are two types of transient noise. The *normal mode* or *transverse* is due to an induced voltage between any two-phase conductors (line-line). This voltage is normally in the low frequency range; it causes damage to personal computers, local networks, and workstations. The *common mode* is due to an induced voltage between any phase conductor, including the neutral and the ground. This voltage can cause more damage than normal mode noise, not necessarily by its presence (2-3 V), but by the induce fluctuation that it produces. The common mode voltage is also produced by the presence of current on the neutral ($E=IZ$) and also because of the non-cancellation of the triplen on the phases that adds up on the neutral. Consequently, common mode voltage produces ground potential differences with other grounds.

Non-linear loads (computers, variable speed drives, etc.) generate harmonics. To save energy or to transform an alternating current into a direct current, their power source takes its current as portions of the 60 Hz sine wave. In doing so, the portions of the sine wave that the power supplies do and do not take causes the sine wave to become deformed and multiple frequencies of 60 Hz are formed. Often, single-phase loads produce triplets (3rd, 9th, etc.), while three-phase loads produce 5th and 7th harmonics. Therefore, electrical equipment and installations that are designed to operate at 60 Hz, can become damaged or unbalanced due to these harmonic frequencies, which are different than the fundamental (60 Hz). The principal problem that arises is the overheating of equipment or conductors. The harmonic distortion rate (HDR) is the ratio between the harmonics and the fundamental load expressed as a percentage.

Voltage surges can be compared to voltage spikes, except they last longer: from 15 microseconds to half a second or more. They are mainly caused by the shutdown of heavily loaded circuits or by the necessary commutation of a high-powered network (ex.: Pf correction). Evidently, computers and other sensitive electronic equipment can seriously be damaged by such an over-voltage surge.

Voltage sags are normally caused by the addition of heavy loads on an electrical line such as the start-up of an elevator, photocopier or large motor. In this case, the current undergoes a loss of 20% or more for a period of 15 microseconds to half a second.

Brownouts last longer than voltage sags. Brownouts are sometimes caused intentionally by the power company to avoid a total blackout when there is a great demand for electricity.

Flickering is a voltage variation with a lighting load that causes the light output to visibly flicker. This can be caused by the input in function of electro-domestic loads; however, it is mostly due to industrial loads (ex.: motor start up or speed variation)

Blackouts can last from a few microseconds to hours or even days. These total losses of current normally occur due to damaged equipment or electrical lines.

Power Factor is the ratio between the apparent power (VA) and the real power (W). Energy suppliers deliver electricity with a sine voltage wave at 60 Hz. If the current and voltage waves are not aligned, the system's efficiency is diminished and the apparent power is greater than the real power. In an inductive system, the voltage wave is ahead of the current wave. In a capacitive system, it is the current sine wave that is ahead of the voltage sine wave. In order to compensate for the inductive effect of motors, correction is achieved using capacitors to align the two waveforms.

There are now two causes that contribute to the deterioration of the power factor: inductive loads, which influence the displacement power factor, and non-linear loads when the current harmonics are not aligned with the voltage source. Utilities measure the total power factor and consider both of these causes.

Knowing the cause for the deterioration of the power factor will help choose best way to correct it. In some cases, correcting harmonic problems can rectify the power factor.

Power Factor Calculations: The power factor ratio measures the relative amounts of work-producing active power measured in kW versus the total apparent power (kVA). Power factor is defined as the cosine (cos) in the following equations:

$$\text{Power factor} = \text{COS}$$

$$\text{Power} = \text{Vrms Irms COS}$$

$$\text{PF} = \text{kW} / \text{kVA}$$

This relationship is shown below in figure 2, Displacement Power Factor.

Power factor is based on the 60 Hz fundamental frequency. Harmonic currents drawn by UPS's, PLC's, adjustable speed drives, electronic ballast and electronic office equipment are increasing in the modern facility. As a result, power factor must now be viewed in reference to harmonic frequencies of the 60 Hz fundamental. Conventional power factor is now called displacement power factor to relate it to the displacement between the system current and voltage waveforms.

Distortion power factor, on the other hand, takes into account the harmonic currents that do not contribute to the real work produced by the load. Distortion power factor is defined as the ratio of the fundamental component of the line current to the total line current. The total power factor is a combination of both displacement and distortion power factors. This relationship, shown in figure 3, is represented as a three-dimensional vector with the kVA value illustrated as the diagonal of a box. Note that the kVA's diagonal line of the box in figure 3 is always equal to or longer than the kVA line shown in figure 2. Thus total power factor is always equal to or less than conventional displacement power factor.

Figure 2: Displacement Power Factor

Power factor is a measure of the relative amounts of work producing active power kW to the total apparent power kva.

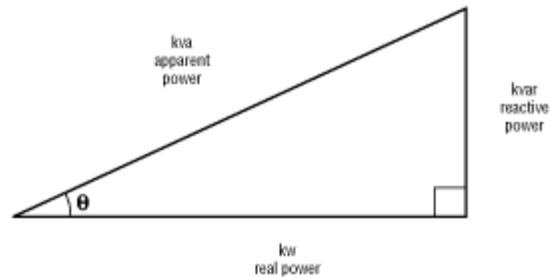
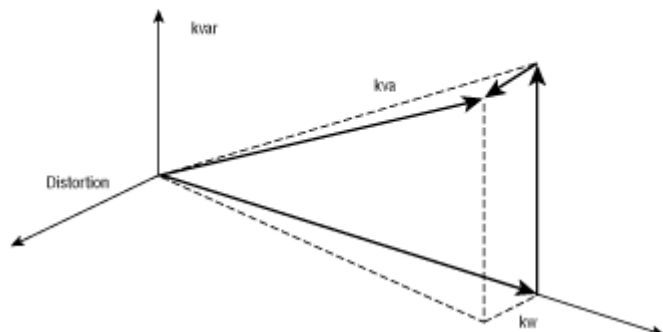

Figure 3: Total Power Factor

Total power factor combines displacement and distortion power factors and is represented as a three-dimensional vector.



Power Factor Measurements

A facility can sometimes determine its power factor by examining its power bill or asking for the information from its Utility. Power factor may be measured or calculated from other measurements such as kW, kVA, or kVAR measurements.

Measurement techniques that consider only the 60 Hz fundamental frequency determine the displacement power factor. This is simply the phase shift between the current and voltage waveforms. Measurement techniques that include current and voltage root-mean-square (RMS) values take into account the effects of harmonic currents to reflect both displacement and distortion power factors. Many solid-state power monitors are available to sample voltage and current waveforms and calculate the electrical parameters. These devices usually indicate both displacement and total power factor.

Equipment

Electrical Problems vs. Computers

Because of voltage fluctuations as well as economic considerations, a non-linear power supply known as the switching power supply, was developed by computer manufacturers. Power conversion is no longer accomplished at 60 Hz. AC-DC conversion is accomplished by a converter, which operates in the 20-100 kHz range.

Personal computers, workstations, local networks and other accessories that use these power supplies or this technology are very sensitive to problems caused by electrical energy. Electrical issues can cause many problems on linear loads and other devices such as transformers, motors, circuit breakers, fuses, etc.

These problems are often very evident. Meanwhile, other hidden electrical problems are caused by voltage spikes, voltage surges, brownouts, as well as by electrical noise on the lines and can bring about different consequences:

- **Voltage spikes**, while brief, can destroy data stored on disk or on magnetic tape, modify memory, and even cause serious damage to equipment (example: the breaking of a disk drive's reading head).
- **Electrical noise** is usually the worst of these problems because we cannot detect it without specialized instruments (ex.: recording device, oscilloscope, etc.). Noise can interfere with data signals by causing data transmission errors between the many components of a system. Certain noise in the high frequencies can even travel through circuit paths and destroy integrated circuits.
- **Harmonics** produce an increase in the resistance of the conductor (skin effect) and, in turn, an abnormal common mode (neutral-ground) voltage difference. This will cause undesirable ground loops to occur.
- **Voltage surges** which exceed normal voltages by 20%, affect numeric data, produce reading errors on verification systems, and damage equipment. Temporal fluctuations produce parity errors and interrupt protection systems.
- **Brownouts** often lead to losses and even unresolved errors concerning central memory data or when data is being stored on disk or magnetic tape. In certain cases, if the brownout lasts long enough, it can cause an automatic shutdown of certain equipment.

Electrical Problems on Non-linear Electrical Systems

A switching power supply takes a portion of the maximum positive energy as well as the minimum negative energy on the sine wave. This deforms the sine wave, provoking a new wave.

Fourier, the French mathematician, demonstrated that this new wave can be broken down as the sum of many waves (harmonics), for which the fundamental is at 60 Hz, and of all the present harmonics, the 2nd at 120 Hz, the 3rd at 180 Hz, etc.

A spectral analysis gives us the amplitude of these waves and allows us to compare the relative importance of each of these.

60Hz	120Hz	180Hz	240Hz	300Hz	360Hz
F	2	3	4	5	6
+	-	0	+	-	0



Rotation Speed and Resistance to Metal Increase

Harmonics spectral analysis IEEE Standard - 519-1992			
Harmonic	Amplitude	Harmonic	Amplitude
1	1.000	9	0.157
3	0.810	11	0.024
5	0.606	13	0.063
7	0.370	15	0.079

The RMS value of a deformed current is given by:

$$I = \sqrt{I_F^2 + I_2^2 + I_3^2 + \dots + I_N^2}$$

$$I = \sqrt{I_F^2 + I_H^2}$$

- I = RMS value of the deformed current
- I_F = RMS value of the fundamental
- I_H = RMS value of the harmonics
- I₂, I₃, I₄, ... I_N = Respective RMS values of the 2nd, 3rd, 4th, ... Nth harmonics

A similar equation is applied for voltage.

Example:

With a current for which the RMS value is 100 A at the fundamental (60 Hz) and 80 A at the 3rd harmonic (180 Hz), the RMS value of the deformed current is therefore:

$$I = \sqrt{100^2 + 80^2} = 128A$$

Electrical Distribution Systems

Harmonics cause fuses and circuit breakers to open a circuit for no apparent reason. An installation capable of supporting a certain amount of linear loads could no longer be able to support it after being replaced with non-linear loads of the same power at 60 Hz. We should be seeing a rapid progression of this type of problem as new non-linear harmonic loads are added or replace traditional linear loads.

With energy saving programs, utilities lead their customers to use switching power supply technology such as variable speed drives and electronic ballasts.

The laws of electricity have not changed but our knowledge of them becomes essential:

- The more the frequency increases, the more the metal becomes resistant (skin effect).

- Certain harmonics are at direct sequences (1, 4, 7, 10), others inverse (2, 5, 8, 11), and others without sequence, are called triplets (3, 6, 9).
- Harmonics can damage transformers.
- Inverse harmonics have harmful effect on motors.
- Harmonics influence the power factor.

In a factory, if we find a certain amount of current harmonics, is there a problem?

Ohm's law (V=IR) with a few exceptions, explains the consequences of these harmonics on inductive and resistive loads. Current distortions will create voltage distortions according to the line impedance. It is well known that for any non-linear load installation, it is very important that the impedance be as low as possible. One should always foresee the consequences of a current distortion on voltage or on the harmonic voltage distortion that it can bring about. Current harmonics are always present in non-linear loads and if they are properly dealt with, they will not always be problem sources.

IEEE Standard 519-1992
Harmonic voltage distortion limits
in % of nominal fundamental frequency voltage.

Bus Voltage at PCC (V _n)	Individual Harmonic Voltage Distortion (%)	Total Voltage Distortion - THD _{Vn} (%)
V _n ≤ 69kV	3.0	5.0
69kV < V _n ≤ 161kV	1.5	2.5
V _n > 161kV	1.0	1.5

$$THD_{V_n} = \frac{\sqrt{\sum_{h=2}^{\infty} V_h^2}}{V_n} \times 100\%$$

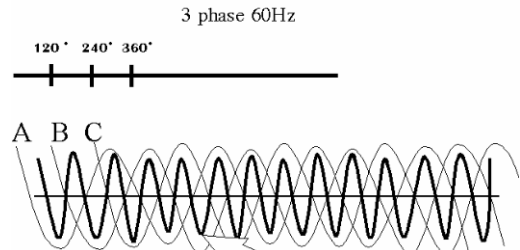

Electrical Conductors

As mentioned earlier, the more the frequency increases the more the metal becomes resistant. Therefore, the current has the tendency to stick to the outer surfaces of the conductor (skin effect). The electric conductor, which was designed for 60 Hz, will heat up when powered up with higher frequencies. Therefore, the conductor must be reclassified. Here is a recommendation from the IEEE Standard 519-1992 on this subject:

Cable declassifications factor in terms of the percentage of harmonics for a 6 impulse three-phase converter used for VSDs.

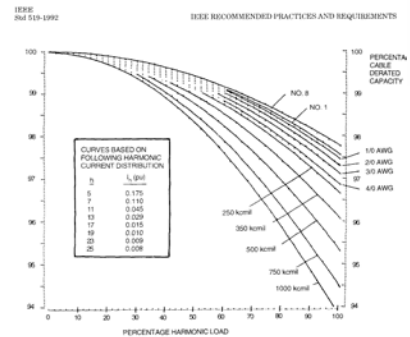

Three-Phase Transformers:

Neutral Problems

On a 60 Hz, delta-wye, 4 wire transformer, if the loads on the phases are well balanced, the current (I) on the neutral side is cancelled at the 60 Hz frequency because of the vectorial sum of each of the phases (120° between each of them).

As per the IEEE Standard 519-1992 on a three-phase system for which the loads are solely computers, for a current of 100 amps at 60 Hz, we find a current of 81 amps at 180 Hz. Given that with 120° between each phase, at the frequency of 180 Hz, there is no cancellation on the neutral; it possesses a current that is the sum of each phase current at 180 Hz. The RMS value of the current on the neutral is therefore greater than the phase current (see *Electrical Problems on Non-linear Electrical Systems*).

The neutral will heat up if it is not of an adequate size for a non-linear load. Also, because of the wire's impedance, a voltage will appear on the load between the neutral and the ground. This voltage can be very damaging for electronic equipment (ex.: signal brought to ground).

Transformer Heating

The transformer overheats because of the increased losses due to the Eddie currents, caused by the presence of harmonics in the winding conductors.

Motors

Motors operate with a positive rotation at a frequency of 60 Hz. So, if the frequency is a negative sequence (ex.: 5th voltage harmonic), the resultant force will provoke heating, as well as a decrease in the total motor torque because this type of frequency brings about an inverse rotational effect on the motor. This phenomenon will bring about an additional stress, which will provoke premature failure of the motors. An unbalanced voltage will bring about a negative rotation sequence.

Capacitors

The usage of capacitors as harmonic filters or power factor correctors is very frequent in industrial electric installations. In certain cases, however, the voltage distortion can provoke a resonant system, meaning that the impedance of the capacitors approaches the inductive impedance of the load at a given harmonic frequency.

Peaks and important voltage distortions will then appear in the system, damaging sensitive equipment. The lifetime of these capacitors will be shortened as well. It is therefore very important to get help from system experts to apply this technology, and be cautious of energy saving promises from those who cannot give a detailed explanation of how this works or the consequences. Also, a correction at the source (non-linear load) of the harmonics will improve and possibly correct the real power factor.

Variable Speed Drives

Variable speed drives have become very popular in industrial electric installations beginning with DC motors and later with AC motors. Both types use the alternating current and transform it to DC to control the motor's speed. However, because of this process, they create current harmonics on the line and are very sensitive to voltage fluctuations.

*IEEE Standard 519-1992
Weighting factors for different types of harmonic producing loads.*

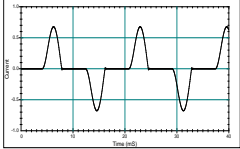
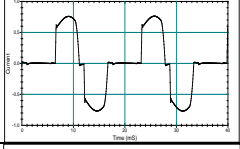
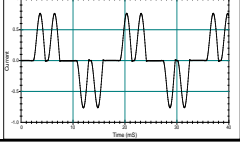
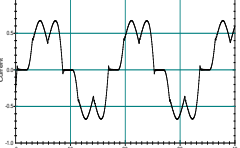
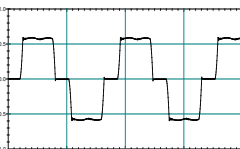
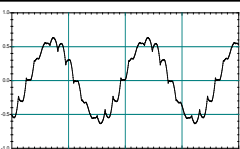
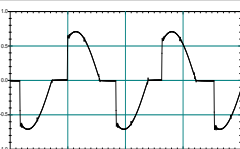
Type of Load	Typical Waveform	Current Distortion	Weighting Factor (W_i)
Single Phase Power Supply		80% (high 3rd)	2.5
Semi Converter		high 2nd,3rd, 4th at partial loads	2.5
6 Pulse Converter, capacitive smoothing, no series inductance		80%	2.0
6 Pulse Converter, capacitive smoothing with series inductance > 3%, or dc drive		40%	1.0
6 Pulse Converter with large inductor for current smoothing		28%	0.8
12 Pulse Converter		15%	0.5
AC Voltage Regulator		varies with firing angle	0.7
Fluorescent Lighting		17%	0.5

Protection of Electrical Systems

There is a great deal of electrical protection systems on the market. The choices we make will depend on the needs and complexity of their application, as well as their cost.

Circuit Breakers and Fuses

When choosing circuit breakers and fuses, the true RMS (Root Mean Square) current values must be taken into consideration. To do this, measurements must always be taken with true RMS value equipment, meaning a current reading including harmonic values (see *Electrical Problems on Non-linear Electrical Systems*).

Peak Cut-Off Circuits

(Transient Voltage Surge Suppressers or TVSS)

These semi-conductors (MOV: metal oxide varistor) are barely conductive below a certain voltage, which become conductive above this voltage. On a 120-volt circuit, if we place this semi-conductor between the line and the ground, when a voltage spike occurs, the semi-conductor will become conductive and will discharge this extra voltage to the ground.

Semi-conductors have a finite life span, and after a certain number of shocks, they can become ineffective. They must be replaced often, each year in some cases, if their tolerance in joules and in maximum peak current becomes too low. Many systems do not allow easy testing of the MOVs.

Here are a few TVSS characteristics to look for:

- They can be equipped with a high frequency filter (10 kHz-100 MHz)
- They must protect against lightning and have at least 500 joules of protection
- They must be easy to replace and come with warning lights in case of failure. In certain cases they should come equipped with an external alarm
- They should never be used in resin or epoxy since it would be impossible to identify the quality of the components. It has also been proven that this method may shorten the life of electronic components
- Low-scale units can become inefficient within six months

Note: Even though they are often called filters or line conditioners, semi-conductors only filter the high frequencies (10 kHz-100 MHz) only if they are equipped with hybrid filters. They never isolate line applications. A transformer must be added to obtain this kind of protection.

Single-Phase Line Conditioning Transformers

Isolation transformers are sometimes equipped with peak cut-off circuits and filters and they can have a galvanic isolation. They therefore become great line conditioners protecting against noise and spikes.

Voltage Regulating Transformers

As well as insuring protection against spikes and surges, voltage regulators filter most of the electric noise which is often a hidden source of problems. Voltage regulators are more expensive than peak cut-off circuits (TVSS), but they protect much better since most are equipped with an isolation transformer. There are three types of voltage regulators on the market: the ferro-resonant transformers, tap switching transformers and the electronic voltage regulator.

Isolated Delta-Wye Transformers

This type of transformer is very popular. They cost less and can also isolate the application from the line.

Peak cut-off circuits, filters and a double electrostatic shield can be added as options for protection against common mode noise and voltage spikes found on the line (for information on harmonics, see *K-type, Delta-Wye for Non-linear Loads*).

Because of the galvanic isolation, there will be a link on the secondary between the neutral and the ground which eliminates the possible voltage between the neutral and the ground on the secondary of the transformer.

To be more efficient, these transformers must, if possible, be installed close to the application.

Since standard transformers were built to support linear loads, they may overheat and become damaged with non-linear loads.

Declassification of a 4 wire Delta-Wye transformer according to CBEMA without K factor:

	PH A	PH B	PPH C	Average
RMS AMPS	310 A	346 A	337 A	331 A
PEAK AMPS RMS	705 A	793 A	729 A	742 A

So:
$$\frac{331 \text{ A} \times 1.414 \text{ (peak factor)}}{742 \text{ A}} = 0.630$$

Then: The KVA of the transformer $\times 0.630 =$ usable KVA

T-connection Transformers (three phases, two coils)

Given the type of asymmetrical connection (3 phases, 2 coils), it is difficult to build a transformer having balanced impedance. Because of the transformation ratio of the coils, the voltage obtained is slightly unbalanced.

K-type Delta-Wye for Non-linear Loads

K-type transformers (K4, K9, K13, K20, etc.) are isolation transformers. They become line conditioners if they are equipped with special electrostatic screens and peak cut-off hybrid filters on the secondary and the primary. K-type transformers are designed to support the supplementary losses due to the harmonic current circulating in the windings.

The number indicating the factor (K4, K9, K13, etc.) is the multiplication factor of the losses due to the Foucault currents in the windings that this transformer can support, following the UL 15.61 standard.

Suggested "K" type Application
<p>K4</p> <ul style="list-style-type: none"> • Electric discharge lighting • Some UPS with input filtering, no Bypass • Induction heating equipment • PLC and solid state control
<p>K13</p> <ul style="list-style-type: none"> • UPS w/o input filtering, with Bypass • Telecommunication equipment • Multi-wire receptacle circuits <ul style="list-style-type: none"> ○ In general care areas of health in hospital facilities and class rooms in schools, etc. ○ Supplying inspection or testing equipment on an assembly or production line ○ Modern Offices
<p>K20</p> <ul style="list-style-type: none"> • Mainframe computer loads • Multi-wire receptacle circuits in critical care areas and operating/recovery rooms of hospitals

The Zero Sequence Filter

In very severe harmonic cases, such as a UPS or a central computer system, it is possible to cancel certain harmonics (triplets) and avoid damage that could be caused to the system on the line (long distance between the line and the transformer) by adding a harmonic mitigating zig-zag transformer.

The zig-zag transformer has been used for a long time to create an artificial neutral with a 3 phase, three wire Delta system. This type of transformer, placed near the load, will create a link between the neutral and the three phases providing a low-impedance path for triplet (3rd, 9th, 15th) and Zero Sequence harmonics of unbalanced systems and thus decreasing the neutral-ground voltage.

There are many different kinds of installations, but these filters must always be wired in parallel. It is very important to understand this technology in order to apply it correctly. Ideally this type of filter should be installed in proximity of the application to achieve best performance.

It will be very important to consider that the installation of these filters will lower the line impedance and increase the short-circuit current. Short circuit protection will have to be adequate.

Phase Angles

At 60 Hz, because of a 120° difference between the phases on a well-balanced three-phase system, the current is cancelled to zero on the neutral; the same technique applies for other frequencies at different angles.

For example, with two variable speed drives of equal capacity, by installing a Delta-Wye transformer (30° with respect to the primary) on one motor and a Delta-Delta transformer (0°) on the other, the common primary of the two transformers will obtain a good cancellation of the 5th and 7th harmonics.

With this approach, we can use all of the non-linear loads and by phase shifting the loads, attenuate the effects of certain harmonics.

Meanwhile, because of the relation between the current and voltage distortions, the impedance takes on important dimensions. Therefore, new transformers have been designed to offer low impedance to triplet-type harmonics and others have been designed to offer low impedance cancellation for other harmonic types.

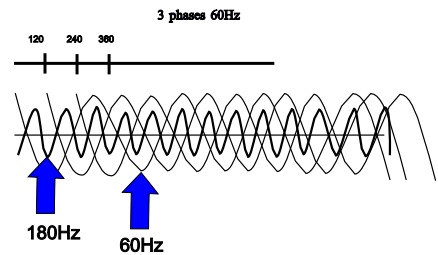

The Harmonic Mitigating Transformer (0° or -30° primary-secondary Phase Shift)

Even if it is possible with a K-type transformer, depending on the quantity of Zero Sequence harmonics (triplets), to support these non-linear loads, how can one know which loads will be applied in 6 months, 1 year, or more?

Special secondary interconnections construction produces a cancellation of the 3rd, 9th, 15th harmonics (triplets). So, if we build a transformer with a Delta primary and a double interconnected winding secondary to cancel the triplen (zero sequence harmonics), we will have:

- An adaptable transformer for non-linear loads
- A low-impedance cancellation of the 3rd, 9th, 15th harmonics
- A better equilibrium of phases and less harmonic voltage distortion (low-impedance Zero Sequence).

An electrostatic screen and a peak cut-off filter could also be installed for additional protection against common mode noise.

The installation of this kind of transformer is the same as for an ordinary transformer. Many existing applications use this type of construction.

Because of its Phase Shifting of 0°, it should be noted that by placing this type of transformer in a system composed of already existent Delta-Wye transformers (-30°), a cancellation of the 5th and 7th harmonics will be obtained. The 5th and 7th harmonics from the transformers will try to cancel the 5th and 7th harmonics coming from the already existent Delta-Wye transformers (-30°). This will also improve the power factor.

The Harmonic Mitigating Transformer Double Output

(ex.: -15°, -45°; or 0°, -30° between the secondary double windings dual output)

This is a transformer with three phases on the primary and six on the secondary, so two sets of three phase outputs on the secondary. Because of the phase shifting between the two sets of three phase outputs:

- A cancellation of the 3rd, 5th, 7th, 9th, 15th, 17th and other harmonics like the 19th on the secondary with a 0° and -30° angle difference and low impedance.
- An improvement in the equilibrium of the phases.
- A cancellation of triplets with only a difference of 0° and -60°.
- A cancellation of the 5th, 7th, 17th and 19th harmonics with an angle difference of -15° and -45°, and the triplets are trapped in the Delta winding.
- An important power factor improvement (see description of the power factor in *Electrical Problems Related to Power Quality*).

Typical and General Construction for a Transformer in a Demanding Environment with Non-linear Loads

Coil connections should be Delta on the primary and Wye on the secondary. Even better, use double windings on the secondary which would diminish harmonic voltage distortions caused by current distortions ($V=IR$); this type of winding cancels triplets (3rd, 9th on the secondary) at very low impedance. To obtain the best resistance to thermal and physical shock, coils should be made from copper, not aluminum. In order to have the same wire resistance between aluminum and copper, it would take 1.6 times the surface of aluminum wire as compared to that of copper.

The K-factor value should be well established with respect to the anticipated loads; for example, K13 can take up to 33% of the fundamental in the 3rd harmonic, 20% in the 5th, 14% in the 7th, and 11% in the 9th.

A high performance grounded electrostatic shield may also need to be installed. As well, peak cut-off circuits and hybrid filters can be installed to make the transformer more efficient in protecting the loads in question.

Stand By Power Supply Systems

These systems provide an electric current source when outages occur. As soon as an outage is detected, the transfer switch starts the AC converter. This transforms the current coming directly from the batteries into an alternating current capable of powering the computer for at least another 10 minutes.

These backup power supplies detect an outage in less than 4 microseconds, which is ample time to prevent interruptions. These units are very inexpensive, but they only offer minimal filtration and no galvanic isolation (neutral-ground), which means that there will be no cancellation of common mode (neutral-ground) voltage. The importance of the network will determine whether or not the savings made are worth it.

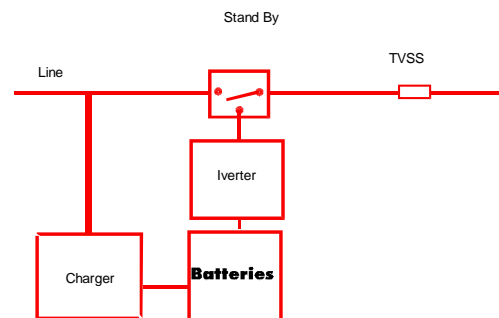

Uninterruptible Power Supplies

These units isolate line to load at all times and are installed between the line and the load. They constantly provide power to keep equipment working (computers, servers, terminals, PLCs, etc.). In a blackout situation, they output a perfect sine wave without any transfer time or interruption. There are four types of UPSs.

The "On Line" Double Conversion UPS

An internal rectifier transforms AC current into DC current. The DC current charges the batteries so they are always ready to be used, and a converter transforms the DC battery current into AC current to power the computer. These sources output clean power and guarantee protection against all forms of electrical problems. Special attention must be given to static switches which usually require a specialized

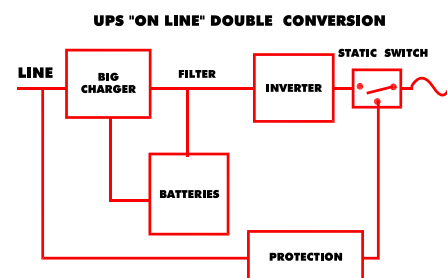

transformer for protection. It should be noted that the battery charger can be a harmonic source that will have to be corrected with filters or by phase shifting.

The "On Line" Simple Conversion UPS

An internal rectifier transforms AC current into DC current. This current charges the batteries while the line powers a ferroresonant transformer which isolates, powers, filters, and corrects the load voltage. It is always ready for use when a blackout or power anomaly occurs. When an outage occurs, a converter transforms battery DC current into AC current to power the load. While this is happening, the ferroresonant transformer's capacitors support the load by saturating the transformer's core. These sources always output clean current and guarantee protection against all forms of electrical problems. This type of product is very well adapted for demanding applications because of its robustness and redundancy.

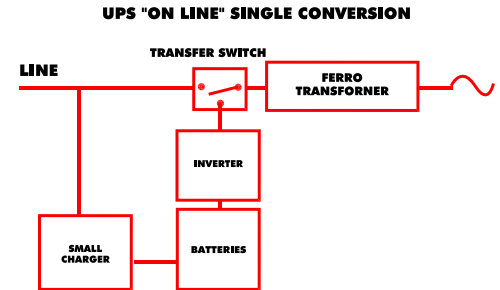

The "Interactive On Line" Simple Conversion UPS

This technology is relatively new. The current is fed to a special isolation transformer which uses the multi-tap method to control its own voltage. A contact is established with a dual-purpose converter (charger and converter) which charges the batteries or helps to stabilize the line. In a blackout situation there is no transfer; the converter uses the batteries to power itself and transforms DC battery current into AC current to power the application.

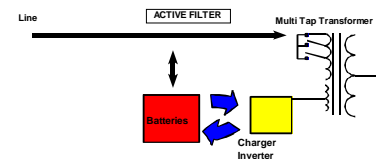

Uninterruptible Power Plants

Normally, a DC motor powered by a rectifier connected to the voltage of the local supply circuit makes a generator turn. This powers the load with an electrical source that is independent of the local supply circuit. When an outage occurs, the initial supply keeps the generator functioning or a battery keeps the DC motor working until the diesel backup generator starts. The diesel motor then takes over for the DC motor for the length of the outage.

The Installation of Dedicated Outlets for Computerized Equipment

It is very important to check the electrical outlet before plugging in a computer. Indeed, this often constitutes the most neglected point of the system. No voltage should exist between the neutral and the ground.

The neutral wire is connected to the ground and to the secondary of the transformer, with the exception of the voltage provoked by the return current. This is caused by the phase unbalances on a three-phase, four wire system or the current of a simple phase system ($V=IR$, very little common mode voltage (neutral to Ground) which should be seen at the receptacle

However, because of harmonic currents, what should have been cancelled in a linear three-phase system is not, and a voltage is found between neutral and ground. In addition, to complicate things even more, the presence of this common mode voltage is an indication of voltage surges due to the commutation of the equipment.

It should be noted that the higher the frequency, the more the wire's resistance increases because the current flows on the exterior surface of the wire. Therefore, the wire acts as though it has a smaller diameter. The impedance corresponds to the wire's resistance, which is proportional to the frequency. The longer the wire, the greater the voltage between the neutral and the ground which will therefore cause problems to the electrical circuit.

Indeed, a high frequency current will heat up the circuits and damage the computers. This situation will be caused by the computerized signals' reference to ground and the standard computer protection (internal filter, internal peak cut-off circuit).

The Ideal Approach

It is essential to plan the installation of outlets for computers, laser printers, and photocopiers in collaboration with computer executives. Depending on the needs, you could then proceed to the installation of dedicated orange, gray, blue (with TVSS) and white outlets.

Type of Receptacles 15A –120V		
Color	Type	Application
White or Black	Ordinary	Standard
Grey	Ordinary	Printer-Copier
Blue	With Protection	Sensitive
Orange	Dedicated Ground	Computer

Dedicated Outlets

A dedicated outlet should signify a less loaded neutral and therefore a less important neutral-ground voltage difference, which has the advantage of prolonging the useful lifetime of computerized systems. But there's more. Most electronic equipment is protected by filters and peak cut-off circuits. Voltage spikes and high frequency noise can be found on the ground. If the equipment is connected to a dedicated circuit, this noise or these voltage spikes will be directed to the panel. In the opposite case, the spikes and noise would find a path through the communication cables of another computer (ground of the signal) and would provoke a ground loop.

Linear loads (heating, incandescent lighting, etc.) do not go well with non-linear loads (computers, laser printers, and photocopiers). In the non-linear family, computers, do not get along well with the electrical properties of laser printers and photocopiers which consume a great amount of current in an abrupt and irregular fashion, affecting the voltage. The voltage fluctuations that they provoke can seriously damage a computer or can even simulate a blackout.

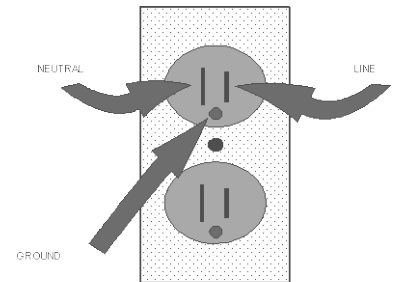

Installation of Outlets

For an adequate installation, we will use the white outlets for traditional linear loads. Then we will reserve dedicated orange outlets for computers and gray outlets for photocopiers and laser printers.

Each outlet will have its own dedicated circuit on a circuit breaker. If you should place many outlets on one circuit, they should be in the same box. They will also have a live wire (black), a neutral (white), and an isolated ground wire. In addition, a naked ground wire allows continuity of grounds and the box.

We will make sure to balance the gray outlets (printers and photocopiers) in the panel, as well as the orange ones (computers) on three phases. Next, the three phases would have to be brought as close as possible to where they will be used in order to minimize magnetic fields (one phase often cancels out another).

Take note that big photocopiers must have their own circuit because their energy demands are large, abrupt and irregular.

Blue outlets with TVSS often constitute a problem, particularly if their ground is shared with an orange or ordinary (black) outlet, and if other computers are connected to it. This type of outlet's internal peak cut-off circuit will direct these voltage spikes to the ground. The voltage spike could also find a shorter path (low impedance) through the communication cable of the computer, which is plugged into the orange outlet. To avoid this kind of situation, a blue outlet should have its own circuit (an outlet = a circuit breaker).

Panel Placement

A panel will be dedicated to linear loads and another to non-linear loads. The one dedicated to the non-linear loads will be three-phase and situated as close as possible to the computers in order to minimize the possibilities of voltage distortion. Indeed, with non-linear loads, we find current distortions and, according to Ohm's law ($V=IR$), impedance amplifies the current distortion to produce a voltage distortion.

A transformer placed as close as possible to this panel will power the isolated ground panel for non-linear loads. Remember that distance plays an important role.

The transformer's neutral will also have to be connected to the ground. On the panel, there should be a wire for the isolated ground connected to an isolated terminal on the panel and another wire on the box itself for the security ground. It is recommended that a flat metallic strip be connected between the isolated terminal and the equipment ground (mechanic); this will improve the equality of the potential of grounds and also could help for dissipation of spikes (33kHz typical).

In addition, the transformer will be composed of a delta winding on the primary and a Wye winding on the secondary. It will be a K-type transformer equipped with a peak cut-off circuit. Better still, for important installations, it is recommended to use a transformer with a delta primary and double windings (Harmonic Mitigating Transformer) on the secondary. This will give a better output due to the cancellation of the Zero Sequence harmonics which will appear at very low impedance on the secondary (see Ohm's law). It will also be important to install peak cut-off circuits (TVSS), be it on the transformer or in the distribution panel, because these hybrid filters (TVSS) will still provide a minimal protection for a dedicated panel.

GLOSSARY OF TERMS

Capacitance:

- Capacitance is the property of a system of dielectrics and conductors that allows for the storage of electrical separated charges when a potential difference exists between the conductors
- A capacitor does not dissipate real energy (Watts)

Converter:

- A device which can be used to change alternating current power to direct current power or vice versa, or from one frequency to another

Faraday Shield:

- A grounded metallic barrier than can be used for enhanced isolation between the windings of an isolation transformer

Filter, band pass:

- A filter that has a single transmission band, neither of the "cut-off" frequencies being zero or infinite

Filter, band reject:

- A filter that has a single attenuation band, neither of the "cut-off" frequencies being zero or infinite

Impedance:

- Propensity of a circuit or device to impede the flow of current
- The real part of impedance is the resistance, and the imaginary part is the reactance

Inductance:

- Represents the propensity of a conductor to store energy in an associated magnetic field
- Opposes the change of AC current but does not oppose the flow of DC
- Can be thought as electrical inertia

Joule:

- Measure of energy
- Joule = Power x Time
- 1kWatt = 3.6 x 10 joules

Metal Oxide Varistor (MOV):

- A semiconductor whose resistance varies inversely with applied voltage
- A commonly used device to clamp or arrest voltage transients

Nominal Voltage:

- Specifies voltage class
- Actual line voltage may vary by location and by time of day loads change
- A 120 V nominal voltage may have measured values of 108 to 132 VAC

Power:

- Rate of energy transfer or consumption
- Power = Voltage x Current (x power factor in AC circuits)
- Units: Watts (Joules/sec)

Power Factor:

- The ratio of watts to volt amperes

Reactance:

- The opposition to the flow of alternating current by the inductance or capacitance of a component or circuit
- Reactance is inductive if the imaginary part of the impedance is positive
- Reactance is capacitive if the imaginary part of the impedance is negative

Rectifier:

- A device which may be used to convert alternating current to direct current (by conducting current easily in one direction and negligibly in the opposite direction)
- A type of converter

Resistance:

- A physical property of circuit that impedes the flow of alternating current which is in phase with the voltage, and restricts the flow of direct current
- When a current flows through a resistance, a voltage drop develops across the resistance (Ohms Law)
- The real part of impedance
- Usually represents the conversion of energy to heat

Resonance:

- Resonance of a circuit or system refers to the enhancement of its response to periodic excitation
- The frequency at which the inductive and capacitive components of an electrical circuit have equal reactance is the resonant frequency. Resonance occurs when a harmonic frequency coincides with the resonant frequency, resulting in very high currents and voltages in the circuit.

Silicon Controlled Rectifier (SCR):

- A type of thyristor

Telephone Interference Factor (TIF):

- A measure of the harmonic interference in telephone circuits are proportional to frequency
- A dimensionless quantity
- Assumes that the coupling between the power and telephone circuits is proportional to frequency

Thyristor:

- A bi-stable semi conducting device comprising three or more junctions that can be switched from the OFF state to the ON state, or vice versa
- Used to convert alternating current to a unidirectional current
- Can be arranged with switching devices to form a thyristor converter

Total Harmonic Distortion (THD):

- Also called the Distortion Factor (DF) or the Harmonic Distortion Factor (HDF)
- Does not include the fundamental